

Part No. NC003198
July 2013

DFX II Series Digital Force Gauge

User Manual



ICONS



WARNING

The raised hand icon warns of a situation or condition that may lead to personal injury or death. Do not proceed until the warning is read and thoroughly understood. Warning messages are shown in bold type.



DANGEROUS VOLTAGE

The lightning icon warns of the presence of an uninsulated dangerous voltage within the product enclosure that might be of sufficient magnitude to cause serious shocks or death. Never open the enclosures unless you are an authorized and qualified Chatillon® service personnel. Never open any enclosure when power is connected to the system or its components.



CAUTION

The exclamation point icon indicates a situation or condition that may lead to equipment malfunction or damage. Do not proceed until the caution message is read and thoroughly understood. Caution messages are shown in bold type.



NOTE

The note icon indicates additional or supplementary information about the action, activity or concept. Notes are shown in bold type.

CAUTION

HIGH FORCES ARE OFTEN INVOLVED WITH THE MATERIAL TESTING PROCESSES.

THE PRODUCT IS NORMALLY USED UNDER BATTERY POWER. HOWEVER, MAINS POWER MAY BE USED.

IF THE EQUIPMENT IS USED IN A MANNER NOT SPECIFIED BY THE MANUFACTURER, THE PROTECTION PROVIDED BY THE EQUIPMENT MAY BE IMPAIRED.

TO MAINTAIN ALL ASPECTS OF THE SPECIFICATION, ONLY AMETEK® APPROVED ACCESSORIES, CONNECTIONS AND COMPONENTS SHOULD BE USED.

STRICTLY ADHERE TO ALL SPECIFIED SAFETY PROCEDURES

READ THIS MANUAL BEFORE USING THIS PRODUCT.

Features



When designing custom fixtures ensure the load rating of the custom fixtures exceed the load rating of the load cell in the force gauge being used. i.e. If the load cell is rated for 100 LBF the custom fixtures should have a load rating greater than 100 LBF.

The DFX II Series have the following standard features:

- $\pm 0.3\%$ of Full Scale Accuracy
- Large, Easy-to-Read LCD Display
- Selectable Units (ozf, gf, lbf, kgf, N)
- Lockable Units
- Normal and Peak Measurement Modes
- Selectable Languages (English, French, Spanish, Portuguese, German, Chinese)
- Automatic Power Save Shutdown
- Battery Operation 70 to 100-hours of continuous use
- Universal Battery Charger
- Internal Calibration Procedure

Introduction

The Chatillon® DFX II Series digital force gauges is a battery-operated force indicator. It uses a NiMH battery for power. It may also be used with the DFX II battery charger/charger (included) supplied.

The DFX II Series may be used to measure and display tensile or compressive loads at an accuracy of $\pm 0.3\%$ of full scale. The DFX II Series may also be set to capture the peak tensile or compressive load. The DFX Series is available in four models having four different capacities and user-selectable units of measurement.

Model	ozf	gf	lbf	kgf	N
DFX2-010	160 x 0.2	5000 x 5	10 x 0.01	5 x 0.005	50 x 0.05
DFX2-050	800 x 1	25000 x 20	50 x 0.05	25 x 0.02	250 x 0.2
DFX2-100	1600 x 2	50000 x 50	100 x 0.1	50 x 0.05	500 x 0.5
DFX2-200	-	-	200 x 0.2	100 x 0.1	1000 x 1

The gauge may be setup to display text in English, French, German, Spanish, Portuguese and Chinese.

Conformance

The Chatillon DFX II Series has been assessed against the essential health and safety requirements of the Low Voltage and the EMC Directives listed and found to be in compliance.

BS EN 61010-1:2010	Safety Requirement for Electrical Equipment
BS EN 61326-1:2006	Electrical Equipment for measurement, control and laboratory use: General Requirements
BS EN 61326-2-3:2006	Electrical Equipment for measurement, control and laboratory use: Transducers with integrated or remote signal conditioning

The DFX II Series is a RoHS and WEEE compliant device.



Packaging

The Chatillon DFX II Series is supplied with the following standard accessories:

- Flat Adapter, 100 lbf (p/n SPK-FMG-011A) or
- Flat Adapter, 200 lbf (p/n SPK-FMG-011B)
- Hook Adapter, 50 lbf (p/n SPK-FMG-012A) or
- Hook Adapter, 100 lbf (p/n SPK-FMG-012B) or
- Hook Adapter, 200 lbf (p/n SPK-FMG-012C)
- DFX II Universal Battery Charger/Charger (p/n charger SPK-DF2-UNIV)
- DFX II Carrying Case (SPK-DF-118)
- Certificate of Conformance

Optional Certificate of Calibration with Data is available.

The DFX II is supplied with one (1) flat adapter and (1) hook. The accessory supplied is dependent on the DFX II capacity.

Display Layout

The Chatillon DFX II Series has a high resolution, dot-matrix LCD, 8 lines, 21 characters. Display contrast is set at the factory and requires no adjustment. The load bargraph, at the bottom of the display, indicates the load currently being applied to the internal load sensor. The bargraph fills from the center location with tensile loads measured to the left and compression loads measured to the right. A load direction indicators shows whether the applied load is tensile or compressive.

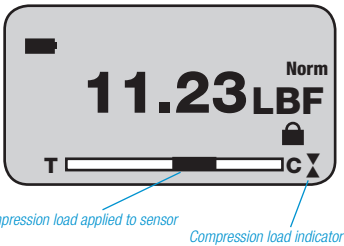
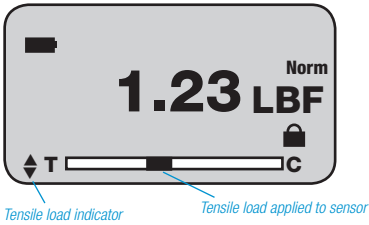
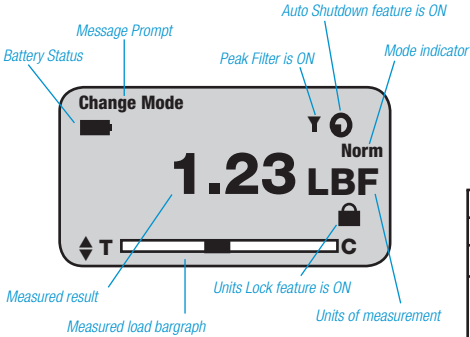

Note

The bargraph fills from the center and load direction indicator appears when load is being applied to the internal load sensor.

Keypad

The Chatillon DFX Series has a rubber keypad containing the following keys:

- On/Off Key
- UNITS Key
- PEAK Key
- ZERO Key
- INFO Key

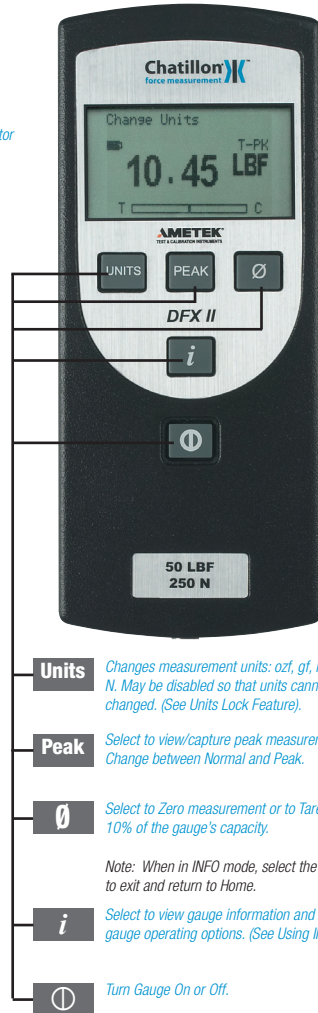

Selecting Mode

The DFX II Series has three measurement modes: Normal, Tension Peak (T-PK) and Compression Peak (C-PK). Select the Peak key to display the peak load measured in tension or compression. Use the zero key to clear the peak reading and to prepare the gauge for the succeeding measurement.

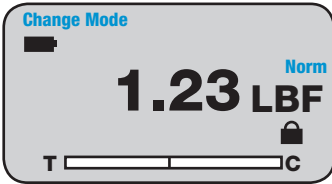

Peak

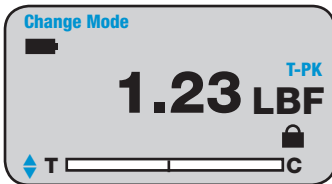

Peak

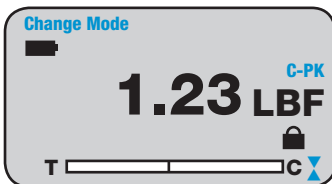

Peak

Zero and Taring

The DFX II Series has a dedicated Zero key for zeroing results or taring. You may tare out up to 10% of the DFX II gauge's rated capacity. Select the Zero key to zero or tare.



0

View Peak Result

The Chatillon DFX II Series will display the peak (maximum) load achieved for a test. There are two methods to view peak results:

1. Place gauge in Normal mode. Apply a push or pull force against the load sensor. Select the PEAK key. View the peak result.
2. Place gauge in Peak mode by selecting the PEAK key before performing the test. Apply a push or pull force against the load sensor. View the peak result.

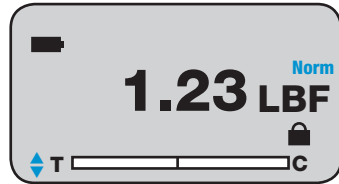

Peak

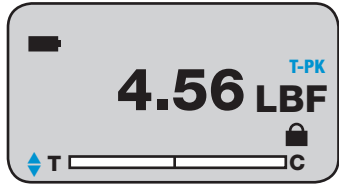

Peak

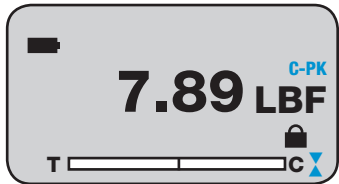

Peak

Note

The corresponding load direction indicator appears when viewing a peak load result or when load is being applied to the internal load sensor.

Using the INFO Key

The INFO (information) key is used to display the gauge's characteristics such as firmware revision. It is also used to view Overloads and to set the Units Lock feature.

Depressing the INFO key cycles the firmware through the following functions:

1. Capacity
2. Firmware Revision
3. Overload History
4. Battery Life
5. Automatic Shutoff
6. Units Lock
7. Display Language

Note

When in INFO mode, you may exit at any time by pressing the ZERO key.

View Capacity

The DFX II Series displays its capacity x resolution. To view the DFX II gauge's capacity characteristics, perform the following key sequence:

1. INFO <Capacity>

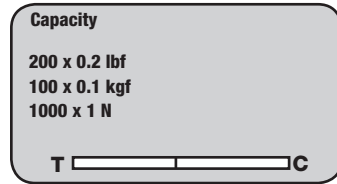

i

View Firmware

The DFX II Series displays its firmware information. To view the firmware characteristics, perform the following key sequence:

1. INFO <Capacity>
2. INFO <Firmware>

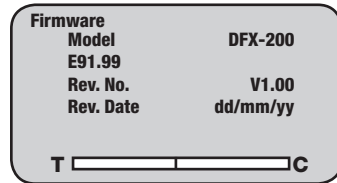

i

View Overloads

The DFX II Series displays its Overload History. To view the overloads, perform the following key sequence:

1. INFO <Capacity>
2. INFO <Firmware>
3. INFO <Overload>

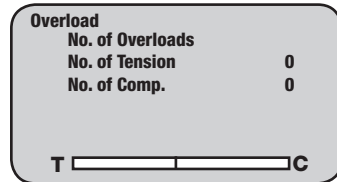

i

IMPORTANT

Overloads can damage the load sensor. Always take special care to observe the bargraph to ensure that the sensor is not being overloaded.

View Battery Life

The DFX II Series displays its battery life. The DFX II uses a rechargeable NiMH battery cell. To view the DFX II battery life, perform the following key sequence:

1. INFO <Capacity>
2. INFO <Firmware>
3. INFO <Overload>
4. INFO <Battery>

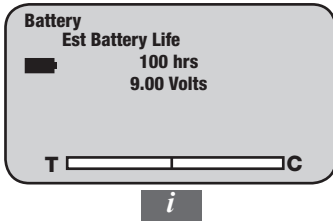

Using The Battery Charger

The DFX II Series may be battery operated or operated using the battery charger accessory (SPK-DF2-UNIV). When the battery charger is used, the internal batteries are charged. The battery charger may be plugged into a 115V or 230V source power outlet. The battery charger contains three interchangeable plug styles: USA, EURO and UK.

1. Place the correct plug onto the battery charger.



2. Plug the battery charger into the source power outlet.



3. Plug the battery charger into the DFX II power input.



4. Press the DFX II On/Off key to turn power ON.



IMPORTANT

Use the Chatillon Battery Charger that comes with the DFX II Series digital force gauge.
Do NOT use generic battery chargers. These can permanently damage the gauge electronics.

Note

The DFX II will display "Recharge Battery" when the battery voltage drops to approximately 4.5VDC

To charge the DFX force gauge plug the phone jack of the supplied universal battery charger into the DFX force gauge then plug the battery charger into the correct AC power outlet. Ensure the correct power is applied to the battery charger. Never plug the USA 2-prong 115VAC charger into a 230VAC power source. To obtain a full charge it is recommended the DFX force gauge is charged for 15-20 hours. The DFX force gauge should get approximately 70 to 100 hours of battery life on a single charge.

A battery icon appears on the main operating display and operates like a bar graph. When the gauge has a full charge, the battery icon appears full. As the battery voltage diminishes, the battery icon will start to empty. You may view the estimated battery life based on current usage in hours by depressing the "i" key until the battery life screen appears.

The DFX force gauge will alert you when the battery assembly needs to be recharged by adding a message to the main test screen "Recharge Battery". The force gauge will shutdown automatically if the battery voltage reaches approximately 4.5VDC.



CAUTION: Do not attempt to charge the Chatillon DFX series force gauge with any other charger than the one supplied with the force gauge or supplied by an authorized Chatillon dealer. The nickel metal hydride batteries are temperature sensitive and the battery charger is specifically design to properly charge this battery assembly without damaging it.

Reversing the Housing

The DFX II Series comes from the factory with the measuring shaft located at the bottom of the gauge when reading the display.

In applications where the measuring shaft is required to be at the top of the gauge, simply reverse the housing.

1. Turn power to the gauge OFF.



2. Remove two (2) 6/32 screws on the gauge housing using Hex key supplied with the DFX II.



3. Rotate the top housing 180-degrees being careful not to strain or damage the internal wiring.



4. Re-assemble gauge housing using two #6-32 hex screws.



DFX II gauges shown with top housing reversed.

Auto Shutdown Feature

The DFX II Series has an option to automatically shut off power when the gauge is not being used during a 30 minute period, e.g. no key presses. To enable the Auto Shutdown feature, follow this setup procedure and depress the following keys:

1. INFO <Capacity>
2. INFO <Firmware>
3. INFO <Overload>
4. INFO <Battery>
5. INFO <Auto Shutdown>

When the Auto Shutdown is ON, the gauge power will automatically be turned OFF after 30 minutes of inactivity, e.g. no key presses. This helps save battery life.

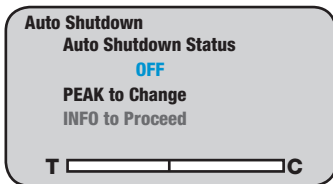

Peak

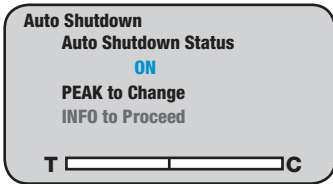

Peak

Automatic Shutdown Indicator when On.

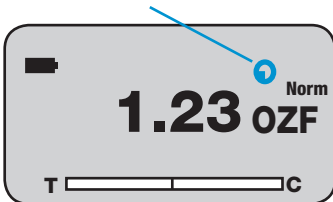

Note

The DFX II will shutdown, when the battery voltage is at approximately 4.5Vdc. Replace batteries or use charger accessory.

Selecting Units

The DFX II Series has a dedicated Units key. Select to display results in different units of measure.

DFX II-010, DFX II-050 and DFX II-100 models may display units as ozf, gf, lbf, kgf or N.

The DFX II -200 will display lbf, kgf or N only.

The Units key may be disabled so that the Units cannot be changed by the operator. See Units Lock Feature.

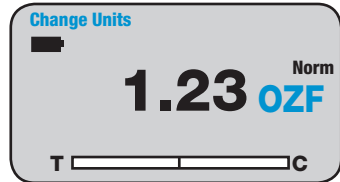

Units

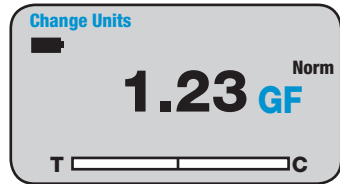

Units

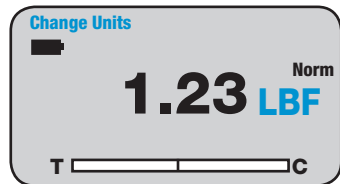

Units

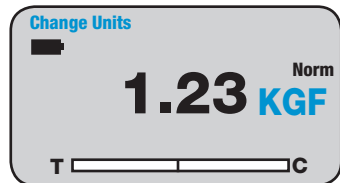

Units

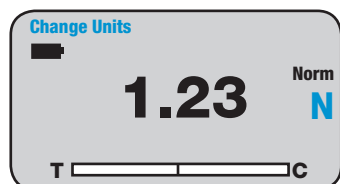

Units Lock Feature

The DFX II Series has an option to “lock the units”. This prevents the operator from changing the units of measure and disables the UNITS key.

To enable the Units Lock feature, follow this setup procedure and depress the following keys:

1. INFO <Capacity>
2. INFO <Firmware>
3. INFO <Overload>
4. INFO <Battery>
5. INFO <Auto Shutdown>
6. INFO <Units Lock>

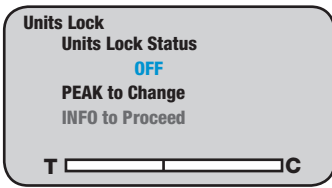

Peak

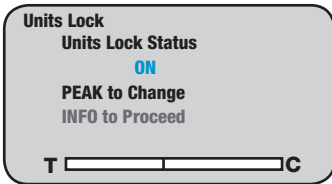

Peak

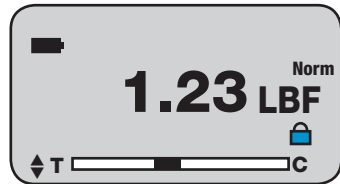

Shown: Units Lock feature is ON.

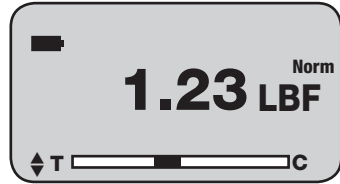

Shown: Units Lock feature is OFF.

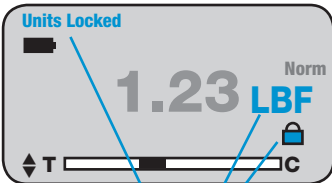

Units

Note

The Units Locked icon appears when this option is ON. Pressing the UNITS key will not change the units of measurement.

Selecting Language

The DFX II Series allows users to select their display language. Textual information can be displayed in the following languages: English, Spanish, French, Portuguese, Chinese and German. To select your display language, follow this setup procedure and depress the following keys:

1. INFO <Capacity>
2. INFO <Firmware>
3. INFO <Overload>
4. INFO <Battery>
5. INFO <Auto Shutdown>
6. INFO <Units Lock>
7. INFO <Language>

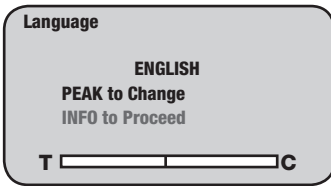

Peak

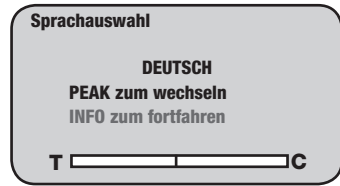

Peak

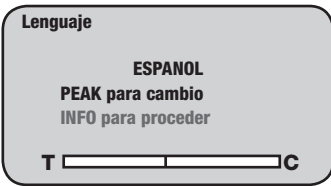

Peak

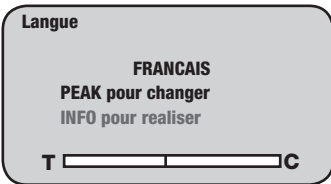

Peak

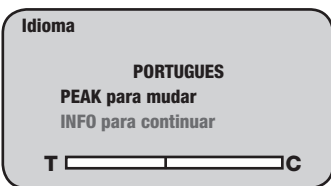

Peak

Enabling Peak Filter

The DFX II Series has a Peak Filter option that controls the sampling rate of the gauge.

The DFX II is shipped from the factory with the Peak Filter ON. An icon on the display indicates when the Peak Filter is ON.

When the Peak Filter is set to ON the Peak Capture is 40Hz. When it is set to OFF the Peak Capture is 1000Hz.

To change the Filter (Sample Rate) for your DFX II, follow this setup procedure and depress the following keys:

1. INFO <Capacity>
2. INFO <Firmware>
3. INFO <Overload>
4. INFO <Battery>
5. INFO <Auto Shutdown>
6. INFO <Units Lock>
7. IINFO <Language>
8. INFO <Filters>

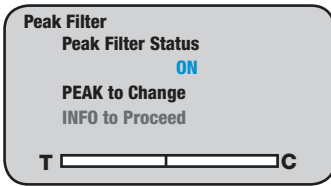

Peak

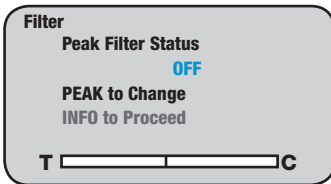

Peak

Affixing Adapters & Fixtures

The DFX II Series has a threaded load sensor shaft. It accepts threaded adapters, grips or fixtures directly. Couplers may be used to adapt to different thread sizes.

The DFX2-010, DFX2-050 and DFX2-100 models have a #10-32 male threaded load sensor shaft.

The DFX2-200 has a 5/16-18 male threaded load sensor shaft.

Be careful to not over tighten adapters as this can damage the load sensor. Adapters should be torqued to 5 in-lbs (45 N-m).

Using Handle Assemblies

The DFX II Series may be used with the optional handle assembly (p/n SPK-DF-HANDLE) or pistol grip (p/n SPK-FMG-141).



(p/n SPK-DF-HANDLE)



(p/n SPK-FMG-141)

Accessories



Chisel Points



Hooks, Stationary



Points



Hooks, Swivel

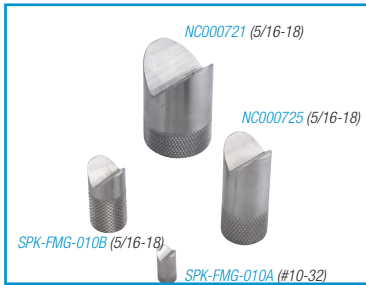

Notches



Couplers

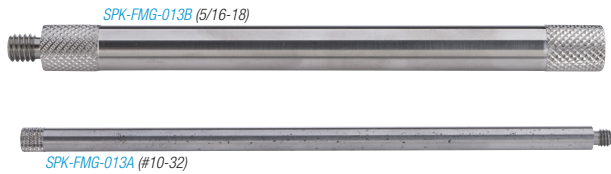

Extension Rods

Mounting Your DFX II to a Chatillon Tester

The DFX II Series may be used with a Chatillon mechanical or motorized force tester. The chart shows the Gauge Adapter Plate that may be required to fit the gauge to the tester.

Test Model	Adapter Part No.
MT150	SPK-MT-0001
MT500	SPK-MT-0004
LTCM-100	Not Required
LTCM-500	Not Required
TT	NC002582

Note

These adapters are especially designed to ensure gauge/tester centerline alignment.



SPK-MT-0001



SPK-MT-0004



NC002582



Shown: The DFX II attached to the MT150 digital force gauge used with the Chatillon MT150 tester. attached to the MT150 crosshead using the SPK-MT-0001 kit (top right)

DFX II Series Calibration

IMPORTANT

Gauge calibration should be performed only by those properly trained to service and calibrate Chatillon instruments. Factory service and calibration is available on these instruments and traceable Certificates of Calibration are provided as requested. Visit www.chatillon.com for a listing of authorized Distributors.

Any changes made to the gauge using the calibration procedure voids the Certificate of Calibration that accompanied your DFX II Series force gauge. Customers electing to calibrate their gauge do so at their risk and with the understanding that they are effecting the performance of the gauge.

The Calibration Procedure described in the following pages will permit a user to calibrate and re-characterize the loadcell being used. Exercise extreme caution when calibrating any precision instrument.

IMPORTANT

The sensor used in your DFX II Series gauge is temperature sensitive. The gauge should be turned ON and allowed to acclimate to ambient temperature before normal use and before being calibrated.

A 5 minute "warm-up" period is recommended.

Calibration Setup

A hanger must be used when calibrating the DFX II Series digital force gauge in compression mode. The hanger will ensure that side loading effects are eliminated. Stacking deadweights onto a platen to perform a compression calibration is NOT acceptable.



Shown: a correct compression calibration setup using a hanger fixture.

Procedure

The Chatillon DFX II Series is supplied with a Certificate of Conformance. The gauge was tested and found to have a measurement accuracy of 0.5% of full scale or better.

Calibration Procedure

The DFX II Series calibration procedure is contained in the gauge firmware. The calibration is a four point calibration: full scale compression, zero compression, full scale tension, zero tension.

To access the calibration routine, begin with the gauge power OFF.

Press the ON key. While the "Chatillon Logo" is displayed, press PEAK then UNITS.

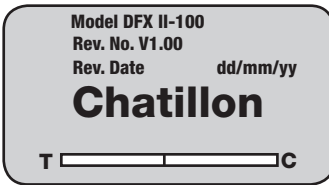

Units

Peak

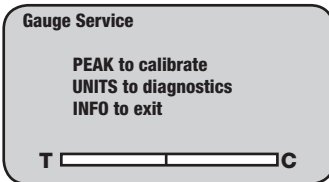

Peak

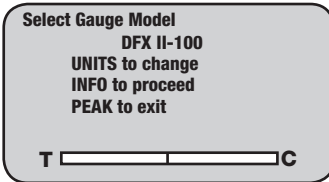

Peak

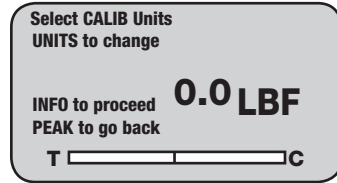

i

Note: The units of measure selected must correspond to the weights that are being used for the calibration.

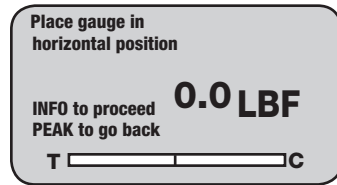

i

Note: Placing the gauge horizontally means to lay the gauge perfectly flat on its backside making sure no load is being applied to the loadcell shaft.

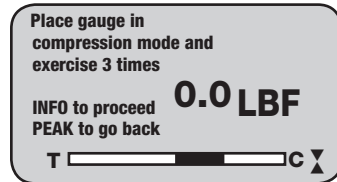

i

Note: You must use a hanger when performing the compression calibration routine to eliminate side load effects on the loadcell.

Note

Selecting PEAK during the calibration procedure will take you back to the last step in the procedure.

DFX II Series Calibration

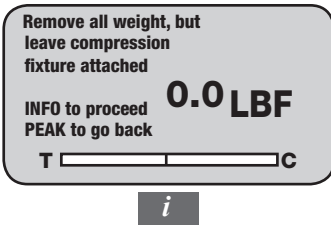

Note: Remove all weights but leave compression calibration hanger attached to the force gauge.

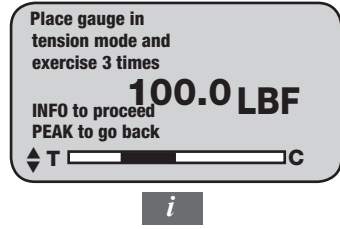

Note: Exercise the loadcell three times by pulling on the loadcell shaft.

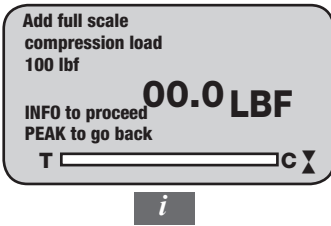

Note: Carefully add weights equal to the DFX II gauge's full scale capacity to the hanger fixture.

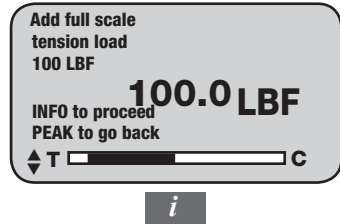
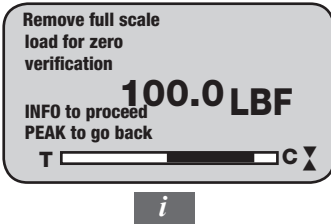
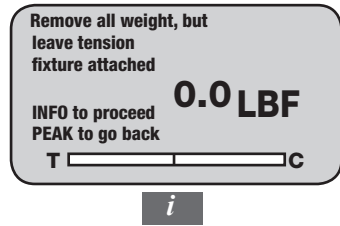

Note: Carefully add weights equal to the DFX II gauge's full scale capacity to the hanger fixture.

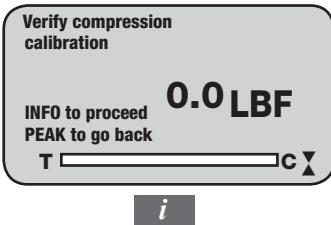

Note: Verify the compression calibration by checking both the full scale (span) and zero. When no load is applied, the display should read zero. When full scale weights are applied to the fixture, the display should read the full scale weight equivalent.

Note
Selecting PEAK during the calibration procedure will take you back to the last step in the procedure.

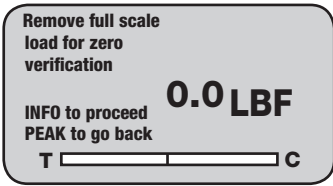

Note: Remove all weights but leave tension fixture attached to the force gauge.

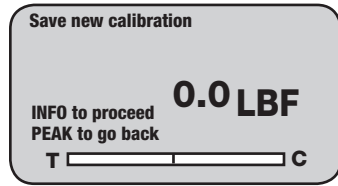

Note: Select INFO to save the calibration.

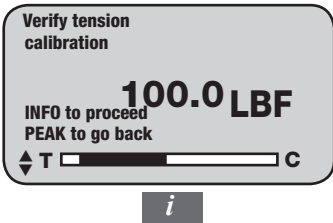

Note: Verify the tension calibration by checking both the full scale (span) and zero. When no load is applied, the display should read zero. When full scale weights are applied to the fixture, the display should read the full scale weight equivalent.

Performing a Tensile Test

The Chatillon DFX II Series may be used to perform a tensile test (also called a pull test). A tensile test causes a pulling effect on the load sensor shaft. The shaft is commonly equipped with a hook adapter or some form of grasping fixture.

Normal Mode Test

Place the gauge into Normal mode by pressing the PEAK key until the mode indicator about the units of measure reads NORM. Normal mode means the gauge will display the real-time load applied to the load sensor shaft. The peak or maximum load is not displayed in Normal mode.

Affix your tensile test adapter (hook, grasping fixture, or the like).

Press the Zero key to zero or tare out the weight of the adapter or fixture attached to the load sensor shaft.

Press the UNITS key to setup your DFX II to display load in your required units of measurement.

Apply a pull force to the load sensor shaft by pulling on the sample under tester.

In a handheld test, make sure to keep the gauge perpendicular to the centerline of the test sample to avoid side loading effects, e.g. where load is not being applied linearly through the load sensor shaft.

In a tester application, where the gauge is mounted to a test stand, ensure that the center line of the load sensor shaft is aligned directly with the sample on the tester.

Observe the load bargraph on the DFX II gauge to guard against overloads. If the bargraph approached being completely filled, stop the test immediately to avoid an overload.

While you are pulling the sample, the tensile load indicator will display (opposing arrows).

Once the test is completed, press the PEAK key to observe the maximum tensile load that was achieved during your test.

Peak Tensile Test (T-PK)

This test is performed identically to the Normal Mode Test except the gauge is placed in PEAK mode. Placing the gauge in PEAK mode automatically “freezes and displays” the maximum load achieved during your test.



Affix Test Adapter

Affix your testing adapter to the DFX II load sensor shaft. “Finger-tight” the adapter to the #10-32 threaded shaft.

Select Normal Mode

Place the DFX II in Normal mode by pressing the PEAK key until “NORM” is displayed above the units indicator.



Select Units of Measure

Select the UNITS key to specify the units of measure you want displayed.

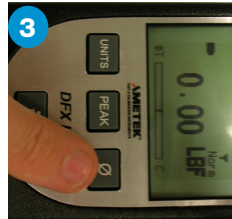

Zero the DFX II

Select the ZERO key to zero the DFX II and to tare out the weight of the test fixture or adapter.

Apply Pull Force

Apply a pulling force to the sample under test. Observe the load bargraph (fills from the center towards the “T”) and the Tensile Load Indicator (arrows). The main display will indicate the load being applied to the load sensor shaft using the fixture/adapter.



Observe Load

Read the force result from the display. If you select the PEAK key after you complete your test, the DFX II will display the maximum (Peak) load that was achieved during the test.

Performing a Compression Test

The Chatillon DFX II Series may be used to perform a compression test (also called a push test). A compression test causes a pushing effect on the load sensor shaft. The shaft is commonly equipped with a flat adapter or platen.

Normal Mode Test

Place the gauge into Normal mode by pressing the PEAK key until the mode indicator about the units of measure reads NORM. Normal mode means the gauge will display the real-time load applied to the load sensor shaft. The peak or maximum load is not displayed in Normal mode.

Affix your compression test adapter (flat, platen fixture, or the like).

Press the Zero key to zero or tare out the weight of the adapter or fixture attached to the load sensor shaft.

Press the UNITS key to setup your DFX II to display load in your required units of measurement.

Apply a pushing force to the load sensor shaft by pushing on the sample under tester.

In a handheld test, make sure to keep the gauge perpendicular to the centerline of the test sample to avoid side loading effects, e.g. where load is not being applied linearly through the load sensor shaft.

In a tester application, where the gauge is mounted to a test stand, ensure that the center line of the load sensor shaft is aligned directly with the sample on the tester.

Observe the load bargraph on the DFX II gauge to guard against overloads. If the bargraph approached being completely filled, stop the test immediately to avoid an overload.

While you are pushing the sample, the compressive load indicator will display (converging arrows).

Once the test is completed, press the PEAK key to observe the maximum compressive load that was achieved during your test.

Peak Compressive Test (C-PK)

This test is performed identically to the Normal Mode Test except the gauge is placed in PEAK mode. Placing the gauge in PEAK mode automatically “freezes and displays” the maximum load achieved during your test.



Affix Test Adapter

Affix your testing adapter to the DFX II load sensor shaft. “Finger-tight” the adapter to the #10-32 threaded shaft.

Select Normal Mode

Place the DFX II in Normal mode by pressing the PEAK key until “NORM” is displayed above the units indicator.



Select Units of Measure

Select the UNITS key to specify the units of measure you want displayed.

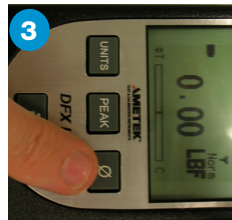

Zero the DFX II

Select the ZERO key to zero the DFX II and to tare out the weight of the test fixture or adapter.

Apply Push Force

Apply a pushing force to the sample under test. Observe the load bargraph (fills from the center towards the “C”) and the Compressive Load Indicator (arrows). The main display will indicate the load being applied to the load sensor shaft using the fixture/adapter.

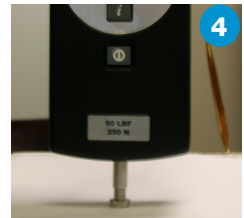

Observe Load

Read the force result from the display. If you select the PEAK key after you complete your test, the DFX will display the maximum (Peak) load that was achieved during the test.

Dimensions

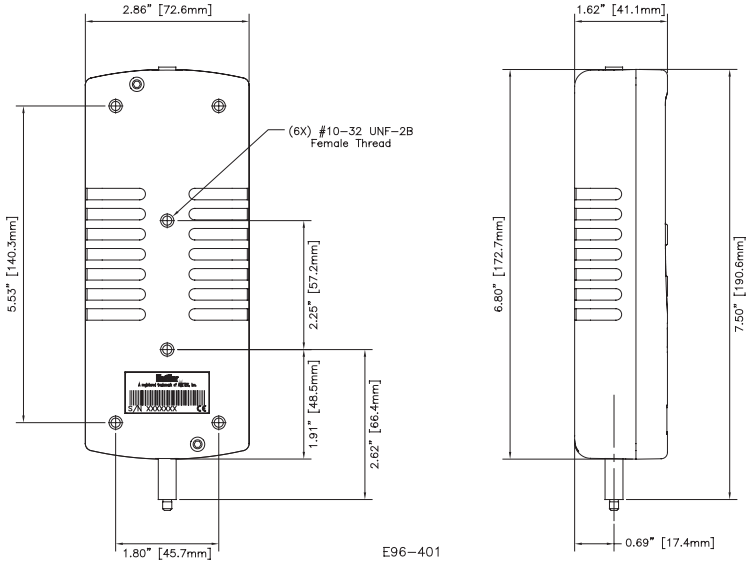

Accessories

Standard Accessories

Description	Part No.
Hook (10 lbf)	SPK-FMG-012A
Hook (100 lbf)	SPK-FMG-012B
Hook (200 lbf)	SPK-FMG-012C
Flat Adapter (100 lbf)	SPK-FMG-011A
Flat Adapter (200 lbf)	SPK-FMG-011B
Protective Carrying Case (small)	SPK-DF-118
Universal Battery Charger	SPK-DF2-UNIV
Hex Key (7/64")	21565

Optional Accessories

Description	Part No.
Point Adapter (100 lbf)	SPK-FMG-009A
Point Adapter (200 lbf)	SPK-FMG-009B
Chisel Adapter (100 lbf)	SPK-FMG-008A
Chisel Adapter (200 lbf)	SPK-FMG-008B
Notch Adapter (100 lbf)	SPK-FMG-010A
Notch Adapter (200 lbf)	SPK-FMG-010B
Extension Rod, 6-inch (#10-32)	SPK-FMG-013A
Extension Rod, 6-inch (5/16-18)	SPK-FMG-013B
Thread Coupler, #10-32 to #10-32	17160
5/8" Eye End Adapter, #10-32	SPK-EYE-1032F
Handle Assembly	SPK-DF-Handle
Pistol Grip	SPK-FMG-141
Soft Carrying Case	NC002845
Functional Capacity Evaluation Kit	FCEK
Muscle Strength Comparison Kit	MSSCK

Note: Supplied accessories depend on the gauge capacity.



DFX2 MODELS

DFX2 ASSEMBLY

ITEM	PART NO.	DESCRIPTION	DFX2-010	DFX2-050	DFX2-100	DFX2-200
1	SPK-DFX2-152-010	TOP HOUSING ASSY, 10 LBF	1			
1	SPK-DFX2-152-050	TOP HOUSING ASSY, 50 LBF		1		
1	SPK-DFX2-152-100	TOP HOUSING ASSY, 100 LBF			1	
1	SPK-DFX2-152-200	TOP HOUSING ASSY, 200 LBF				1
2	SPK-DFX-153	KEYPAD, DFX	1	1	1	1
3	SPK-DFX2-154	PC BOARD ASSY, DFX2	1	1	1	1
4	SPK-DFX-155-010	LOAD CELL ASSY, 10 LBF	1			
4	SPK-DFX-155-050	LOAD CELL ASSY, 50 LBF		1		
4	SPK-DFX-155-100	LOAD CELL ASSY, 100 LBF			1	
4	SPK-DFX-155-200	LOAD CELL ASSY, 200 LBF				1
5	SPK-DFX2-156	BOTTOM HOUSING ASSY	1	1	1	1
6	SPK-DF-114	POWER JACK CABLE ASSY	1	1	1	1
7	SPK-DFX2-158	BATTERY ASSEMBLY, DFX2	1	1	1	1
8	SPK-DF2-UNIV	BATTERY CHARGER, UNIVERSAL	1	1	1	1
9	SPK-FMG-015	HEX KEY	1	1	1	1
10	SPK-FMG-011A	ADAPTER, FLAT	1	1	1	
10	SPK-FMG-011B	ADAPTER, FLAT				1
11	SPK-FMG-012A	ADAPTER, HOOK	1			
11	SPK-FMG-012B	ADAPTER, HOOK		1	1	
11	SPK-FMG-012C	ADAPTER, HOOK				1
12	SPK-DF-118	CARRYING CASE ASSEMBLY (NOT SHOWN)	1	1	1	1
13	SPK-DFX2-160	OPERATION INSTRUCTIONS, DFX2 (NOT SHOWN)	1	1	1	1

E96-445 SHT 2 OF 2
 SPK-GAUGE-DFX2

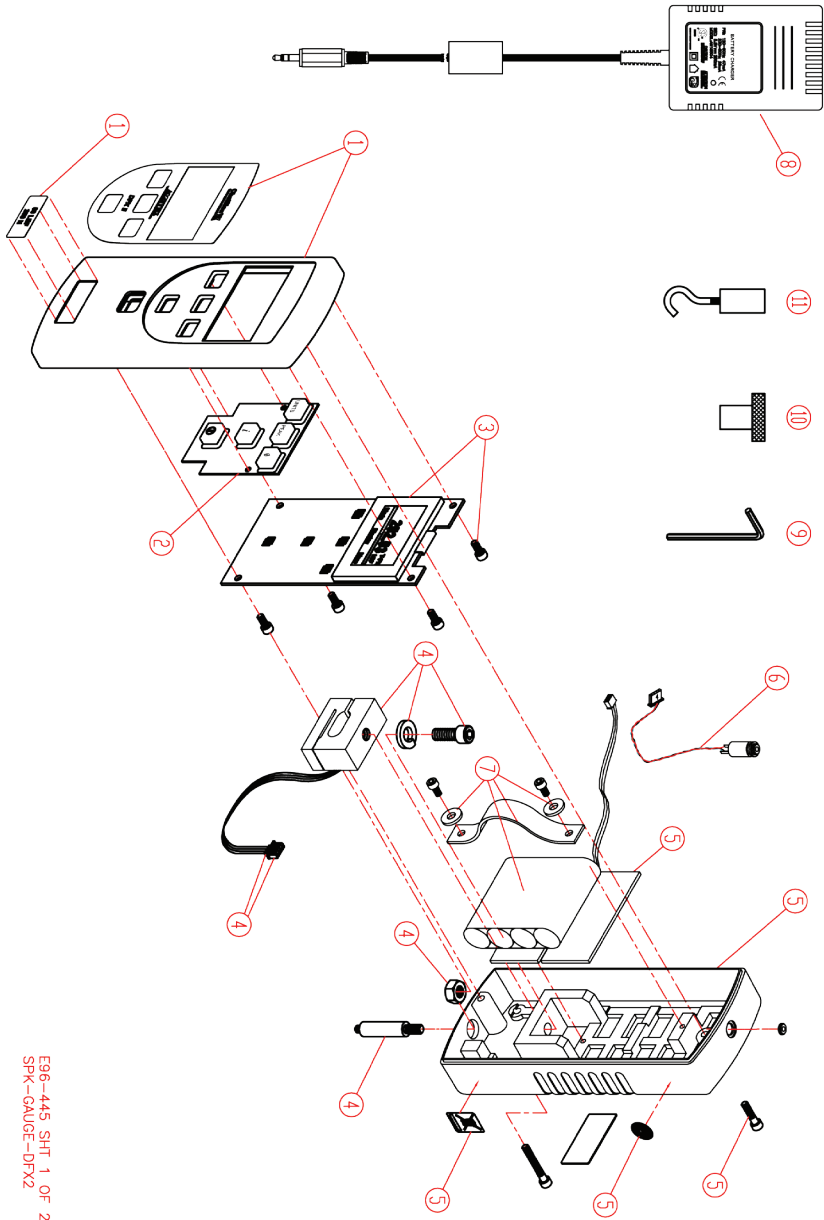

E96-445 SHT 1 OF 2
 SPK-GAUGE-DFX2

Troubleshooting

Symptom	Possible Solution
No display when power button is pressed.	Plug into source power with Universal battery Charger. Check battery connections. Plug into source power with DFX II Battery Charger
Bargraph is partially filled with no load applied to loadcell shaft.	Loadcell zero shift. Recalibrate the DFX II. Loadcell has been damaged and requires replacement.
Display goes blank after 30 minutes.	Automatic shutoff feature is turned ON. Press the "i" key to turn the Automatic Shutoff feature OFF.
Display goes blank.	Battery power voltage has dropped to below 4.5Vdc. DFX II automatically shutdown at power below 4.5Vdc.
Cannot change units of measurement by pressing the Units key.	Units Lock feature is turned ON. Press the "i" key to turn Units Lock feature OFF.
Displayed information is in a different language.	Press the "i" key to select the preferred display Language.
"Change Mode" message is displayed.	Select the Zero key to clear message.
"Change Units" message is displayed.	Select the Zero key to clear message.

Product Warranty

This instrument is warranted against defects in workmanship, material and design for one (1) year from date of delivery to the extent that AMETEK will, at its sole option, repair or replace the instrument or any part thereof which is defective, provided, however, that this warranty shall not apply to instruments subjected to tampering or, abuse, or exposed to highly corrosive conditions.

THIS WARRANTY IS IN LIEU OF ALL OTHER WARRANTIES WHETHER EXPRESS OR IMPLIED AND AMETEK HEREBY DISCLAIMS ALL OTHER WARRANTIES, INCLUDING, WITHOUT LIMITATION, ANY WARRANTY OF FITNESS FOR A PARTICULAR PURPOSE OR MERCHANTABILITY. AMETEK SHALL NOT BE LIABLE FOR ANY INCIDENTAL OR CONSEQUENTIAL DAMAGES, INCLUDING, BUT NOT LIMITED TO, ANY ANTICIPATED OR LOST PROFITS.

This warranty is voidable if the purchaser fails to follow any and all instructions, warnings or cautions in the instrument's Instruction Manual.

If a manufacturing defect is found, AMETEK will replace or repair the instrument or replace any defective part thereof without charge; however, AMETEK's obligation hereunder does not include the cost of transportation which must be borne by the customer. AMETEK assumes no responsibility for damage in transit, and any claims for such damage should be presented to the carrier by the purchaser.

Specifications

Performance Specifications

Accuracy: $\pm 0.3\%$ of full scale

Certification: Certificate of Conformance (standard). Calibration with NIST Data, IEC/ISO17025 (optional).

Data Sampling Rate: 1000 Hz

Peak Capture Rate: 1000 Hz

Display Update Rate: 250ms

Tare Capacity: 110% full scale

Overload Protection: 150% full scale

Display Characteristics: High resolution, dot-matrix LCD, 8 lines, 21 characters.

Automatic Shut Down: 30 minutes. May be disabled.

Power: NiMH battery

Battery Life: Approximately 70 to 100 hours, continuous use.

Instrument Weight: 1.5 lbs (0.7 kg)

Shipping Weights (with accessories): 4 lbs (1.8 kg)

Warranty: 1 year

Environmental Specifications

Storage Temperature: 0° to 130°F (-17° to 54°C)

Operating Temperature: 40° to 110°F (4° to 43°C)

Temperature Stability: Better than 0.03% of rated output per $^{\circ}\text{F}$

Relative Humidity: 20% to 85%

Loadcell Deflection Specifications

The following are the specified loadcell deflection values at full capacity.

Capacity	Deflection
10 lbf (50N)	$0.010'' \pm 0.004''$
50 lbf (250N)	$0.010'' \pm 0.004''$
100 lbf (500N)	$0.010'' \pm 0.004''$
200 lbf (1000N)	$0.010'' \pm 0.004''$



International Symbols

WEEE Directive

This equipment contains electrical and electronic circuits and should not be directly disposed of in a landfill site.



ISO9001:2000
ISO/IEC17025

AMETEK[®]
TEST & CALIBRATION INSTRUMENTS

www.chatillon.com

UK

Lloyd Instruments Ltd
Tel +44 (0)1243 833 370
uk-far.general@ametek.co.uk

France

AMETEK S.A.S.
Tel +33 (0)1 30 68 89 40
general.lloyd-instruments@ametek.fr

Germany

AMETEK GmbH
Tel +49 (0)2159 9136 510
info.mct-de@ametek.de

Denmark

AMETEK Denmark
Tel +45 4816 8000
ametekdk@ametek.com

USA

AMETEK Measurement & Calibration Technologies
Tel +1 (727) 538 6000
chatillon.fl-lar@ametek.com

India

AMETEK Instruments India Pvt Ltd.
Tel +91 22 2836 4750
ametekdk@ametek.com

Singapore

AMETEK Singapore Pte Ltd
Tel +65 6484 2388
ametekdk@ametek.com

China

AMETEK Commercial Enterprise - Shanghai
Tel +86 21 5868 5111
AMETEK Commercial Enterprise - Beijing
Tel +86 10 8526 2111
AMETEK Commercial Enterprise - Guangzhou
Tel +86 20 8363 4768
lloyd@ametek.com.cn